



Pilous

Železná 9, 619 00 Brno, Czech Republic

Tel.: +420 543 25 20 10

e-mail: wood@pilous.cz, www.pilous.cz

CTR 710 M



4140 x 34-41 x 0,9-1,1 mm

Max. log diameter	710 mm
Max. opening between blade guides	660 mm
Max. elevation of blade	630 mm
Min. log height	30 mm
Max. depth of cut	450 mm
Max. log length (standard model)	2,1 m
Length track section	1 m / 3 m
Min. log length	1 m
Saw blade motor	5,5 (7,5) kW
Vertical feed motor	0,55 kW
Sawblade	4140 x 35÷40 x 0,9÷1,1 mm
Weight (standard model)	680 kg
Weight (track section)	25 kg / 97 kg

Nominal current of circuit breaker is minimally 20 / 32 Ampere

DESCRIPTION

Feed into the cut and back – hand-operated

Arm height adjustment – motor-powered

Control panel – on a mobile bridge

Log handling – manual

Smaller, but truly professional saw band in all respects. Execution of main technical parts, such as the running wheels in their mounts, construction of the saw band arm, engine and feeding systems, etc., are completely identical to those in CTR 800 series or in very powerful CTR 950 Hydraulik and CTR 1000 H/40. Simple hand feed into the cut and back. Motor-powered saw band arm height adjustment. In this version of the machine the control panel is placed on a mobile bridge of the saw band arm. Thanks to that the operator has closer access to the workpiece when cutting.

The massive saw band arm is borne on adjustable hard-chromium rods (for moving up and down) which ensure absolute accuracy of saw band arm movement and virtually unlimited service life, if the machine is lubricated regularly. The vertical movement of the arm is provided by double-sided synchronous chain transmission powered by an electric motor with worm gearbox. The movement controlled from the central panel has two modes of speed – rapid feed and slow feed for accurate movement to a desired position. This system can be always additionally equipped with electronic metering which automatically moves to the specified position.

The arm is fitted with running wheels made of high-quality grey cast iron with accurate balancing against vibrations.

The wheel has a groove along its circumference. The groove holds a replaceable rubber-textile belt which creates an optimum contact area between the wheel and the saw band.

The sturdily mounted running wheel is powered through a wedge belt by a professional electrical motor specially balanced against vibrations.

The tensioning wheel system moves along a sturdy cast iron wedge guide with adjustable pressure bar, which allows highly accurate adjustment without any free travel even in long-term machine operation.

CTR series present the latest trends in construction of log saw bands with a special emphasis on maximum accuracy and long-term service life of the machine while ensuring minimum costs. The machines are designed in an original modular execution which allows easy replacement or adjustment of all main technical sections and their individual parts. This in the long-term perspective reduces the maintenance costs, service times and therefore production stoppages as well.

PHOTOGALLERY

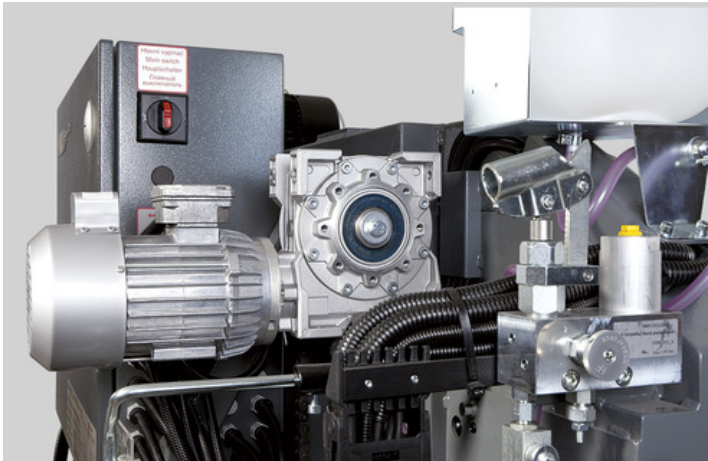
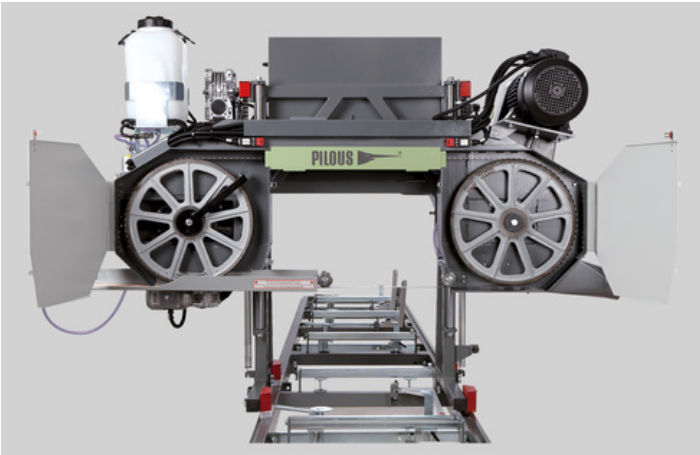
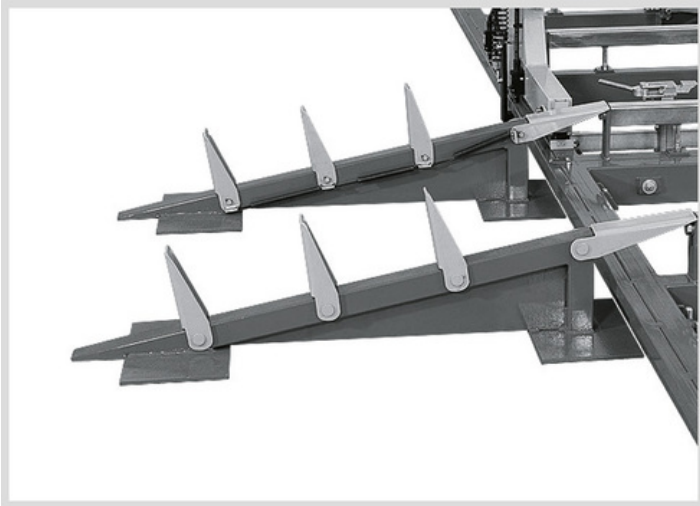

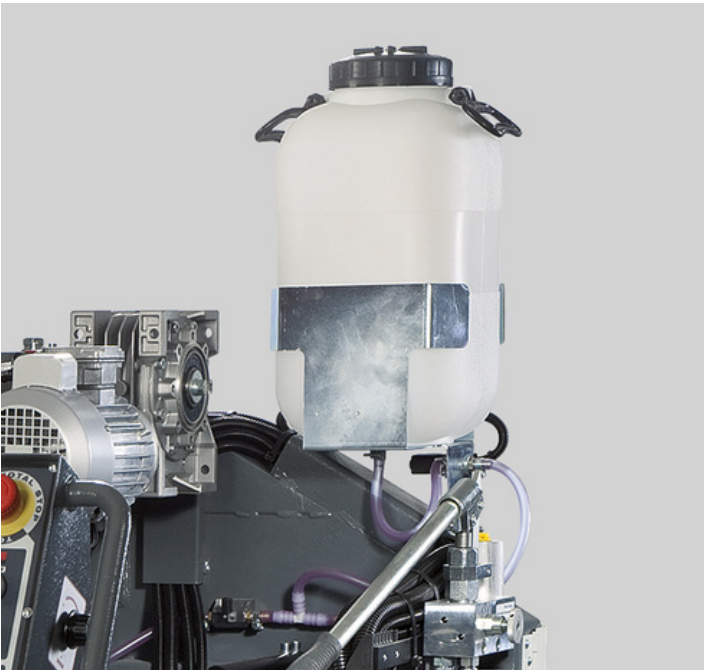
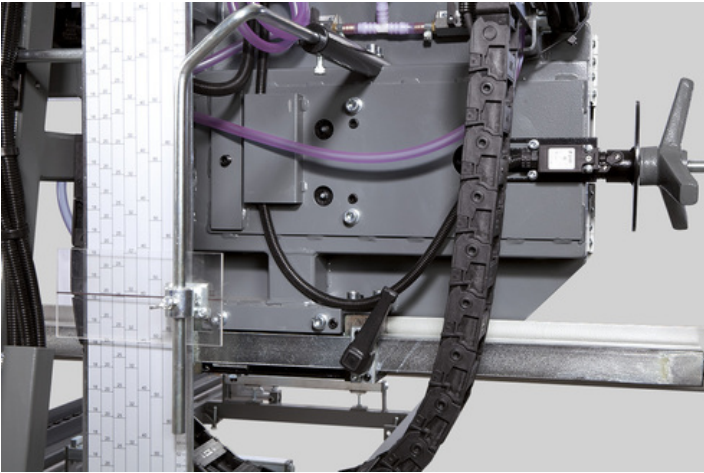
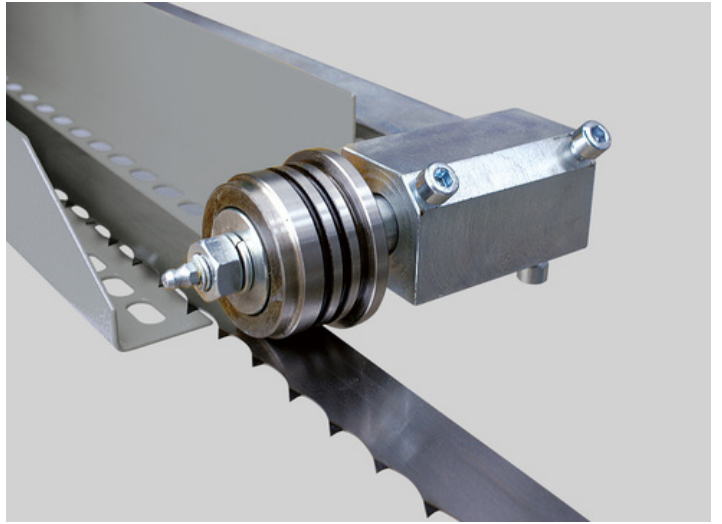

ACCESSORIES

ACCESSORIES – SPECIAL ACCESSORIES



Main motor 7,5 kW

Main motor 7,5 kW

Stronger output of motor provides faster cut, mainly with huge diameters of logs.



1 m (3 m)

Track section 1 m

Track section

1 meter – basic rails only
3 meter – contain in basic: 3x cross beams, 2x angle arms.
Another variable points: 3x material clamps.



LG 100

LG 100

It is intended for a quick and accurate setting of required board thickness. The movement of the band saw arm up and down is displayed with an accuracy of 0.1 mm on a colour display. The absolute height from the band saw bed or, after reset, the set board thickness including the optional kerf thickness is displayed.



LG Automat

LG automat

Digital measuring system for fast and accurate automatic setting of the desired thickness of the cut. After the specification of basic settings (height from the loading area and cut-through) and of the desired value (cut thickness), the arm with a saw band will automatically move to the required position. That prevents human-induced failures that can arise during manual cut settings. Saves time, refines production.

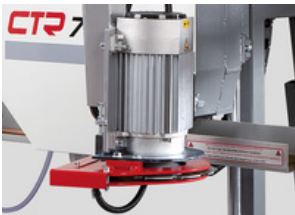

Pre-cutter

Pre-cutter

The pre-cutter circular with hard metal tips is designed to remove dirt at points where the saw blade cuts into the log. The saw blade do not get blunt quickly. Frequent saw blade exchanges are reduced, the saw blade life, and the productivity of the machine increase.

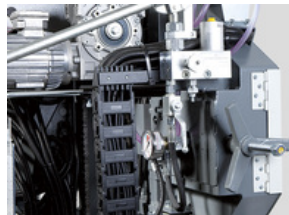

Hydraulic saw blade straining

Hydraulic saw blade straining

Operated by a hydraulic hand pump with accurate pressure indication. The saw blade straining is more accurate and convenient.



Ammeter

Ammeter

The ammeter scale shows the saw blade engine load during the cut. It is designed to simplify the selection of the feed speed; it also indicates the saw blade bluntness. A timely exchange of the saw blade increases the life-span and improves the cutting quality.



Lever for log loading

Lever for log loading

Serves as help with manipulation with logs on machine frame.

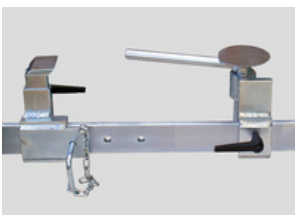

Material Clamp

Material Clamp

Consists of a rail and a front and rear clamp.

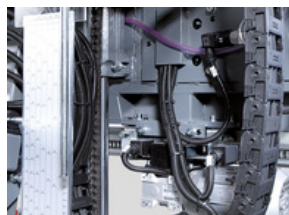

Electrically controlled bar 710

Electrically controlled bar

Adjustment of sliding guide bar of the saw blade depending on the log diameter electrically controlled from the central control desk.

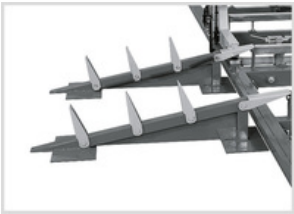

Route for feeding logs

Route for feeding logs
Provides easy and safe manipulation on machine cross beams with system of flexible stops.

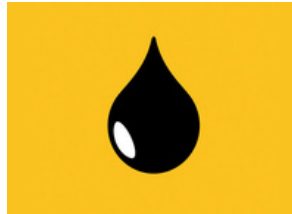

Saw band cooling control

Saw band cooling control
Integrated in the cooling system is an electromagnetic through-flow valve, which automatically opens when the saw blade is started and closes when the saw blade is stopped. It substantially lowers the coolant consumption and saves time needed for replenishment of coolant liquid.

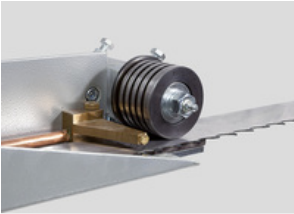

Pressure two-sided saw band cooling

Pressure two-sided saw band cooling
The cooling system consists of a pressure pump in the coolant tank, flow control solenoid valve and two-way jets that spray the saw band both from below and from above. Two-side cooling prevents undesirable stress in the saw band and adhesion of resin from underneath the saw band and thus helps maintain stabler saw band operation, more accurate cut and longer service life.



ARCTIC version

ARCTIC version
Version of the machine adapted for work in extremely cold operating temperatures reaching down to -40 °C. Machine's switch board, control panel and digital measuring (LG 100, LG Automat) are fitted with heating elements. The heating is controlled through a thermostat. Frost-resistant lubricant. Band saws CTR 800 H, 950 H, 1000 H and 1300 H use frost-resistant hydraulic oil.



Hand Operated Grease Gun

Hand operated grease gun
For regular maintenance of the machine according to the lubrication plan. Metal grease gun for 400g cartridges. Equipped with a flexible pressure tube.



Grease LV 2-3

Grease LV 2-3
400g cartridge for the grease gun.

ACCESSORIES – CONSUMABLE PARTS

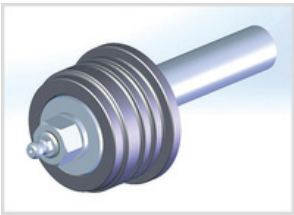

Saw Band Guide Pulley VK 35

Saw band guide pulley VK 35
Hardened ground pulley, bearings, shaft for a saw band 35 mm wide.

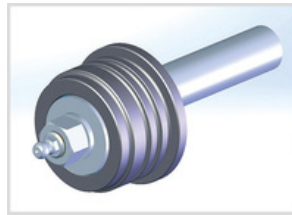

Saw Band Guide Pulley VK 40

Saw band guide pulley VK 40
Hardened ground pulley, bearings, shaft for a saw band 40 mm wide.

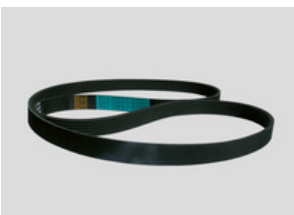

Flat Running Wheel Belt GPK 1550

Flat running wheel belt GPK 1550

MAXWOOD

- The original saw blades PILOUS MAXwood are available in a variety of types which enables you to process any kind of wood.
- The wide product range not only offers more affordable saw blades for low-volume cutting, but includes also saw blades for fully professional cutting and utmost performance.
- The foundation of all saw blades are top-quality German materials and precise workmanship. The quality of the saw blades is carefully monitored. All saw blades correspond to the strict ISO 9001 norm.
- We have added to our portfolio also an original Munkfors saw blade made by the world's leading manufacturer Uddeholm from Sweden.
- Pilous saw blades are used in dozens of countries around the world. Any wood you cut, the company Pilous will recommend you a saw blade that will fit your needs.

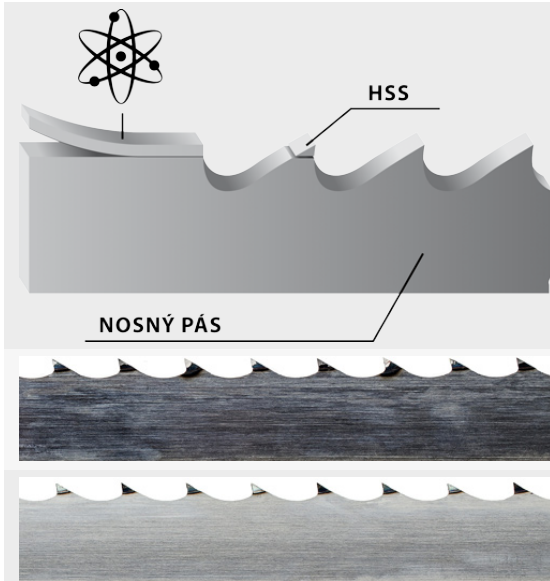

BiMetal

Saw blade with tool steel teeth - completely eliminates the need to sharpen the saw blade as well as frequent blade replacement. Use: soft, hard to extremely hard wood.

HSS

Bearing blade

Stellite

Saw blade with teeth made of Stellite. Tooth setting is completely unnecessary. Use: soft, hard to extremely hard wood.

Carbon spring steel

The most common saw blade for optimum price/performance ratio. Use: soft and hard wood.



Be careful when unpacking welded saw blades. They are in a shipping container in tensioned condition. Remove the saw blade cover only after fitting it onto the machine.

